



BULLWARK

Tools For Professional

Price List

Baby Vice - Clamp Type



Size	Price
32 mm	403/-
40 mm	462/-
50 mm	524/-
60 mm	645/-
75 mm	1,014/-
100 mm	1,382/-

Baby Vice - Clamp Type Revolving



Size	Price
32 mm	554/-
40 mm	585/-
50 mm	614/-
60 mm	922/-
75 mm	1,228/-

Baby Vice - Swivel Base

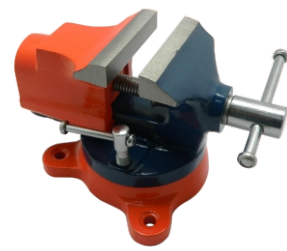

Size	Price
32 mm	554/-
40 mm	585/-
50 mm	614/-
60 mm	922/-
75 mm	1,067/-

Baby Vice - Fixed Base



Size	Price
32 mm	403/-
40 mm	462/-
50 mm	524/-
60 mm	645/-
75 mm	1,014/-

Bench Vice



Size	Price
3"	1,650/-
4"	2,517/-
5"	3,414/-
6"	4,455/-
8"	7,055/-

Drill Vice - 3 Way



Size	Price
4"	4,171/-

Drill Vice - Uni Grip



Size	Price
3"	2,363/-
4"	2,919/-
5"	4,451/-

Drill Vice - Heavy Duty



Size	Price
3"	2,363/-
4"	2,919/-
5"	4,451/-
6"	6,120/-

Wood Working Vice - Rapid Action



Size	Price
7"	3,628/-
9"	4,730/-

Wood Working Vice - Economy



Size	Price
6"	1,208/-
7"	1,450/-
9"	2,176/-

Wood Working Vice - Quick Action with Dog



Size	Price
7"	3,870/-
9"	6,048/-
10"	7,016/-

Wood Working Vice - Standard



Size	Price
7"	2,660/-
9"	4,354/-

Pipe Vice- Hinged (GT Model)



Size	Price
1 Number	1,465/-
2 Number	1,860/-
3 Number	2,620/-
4 Number	4,050/-

C - Clamp Drop Forged



Size	Price
2"	250/-
3"	339/-
4"	500/-
6"	737/-
8"	1,091/-
10"	2,112/-
12"	2,529/-
14"	3,024/-
16"	3,444/-

Anvil



Size	Price
50 Kg Semi Steel Body	6,510/-

Nylon Hammer - Light Head Steel Handle



Size	Price
30 mm	455/-
40 mm	587/-
50 mm	587/-

Nylon Hammer - Solid Head Steel Handle



Size	Price
30 mm	472/-
40 mm	587/-
50 mm	662/-

Nylon Hammer - Non Rebound

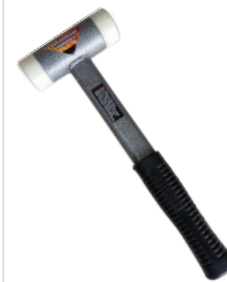

Size	Price
40 mm	635/-
50 mm	730/-

Nylon Hammer - Casted Head



Size	Price
30 mm	455/-
40 mm	610/-
50 mm	730/-



Safety Collar

Nylon Hammer - Light Head Wooden Handle



Dia	Size	Price
30 mm	370 Gms	488/-
40 mm	510 Gms	605/-
50 mm	660 Gms	656/-



Safety Collar

Sledge Hammer - Ergo Hickory Handle

Size	Price
1-LB	165/-
1.5-LB	208/-
2-LB	363/-
3-LB	490/-
4-LB	587/-
6-LB	1,074/-
7-LB	1,136/-
8-LB	1,267/-
10-LB	1,465/-
12-LB	1,730/-
14-LB	1,923/-

Sledge Hammer (Tough Fibre Glass Handle with Moulded Rubber Grip)



Size	Price
1-LB	191/-
1.5-LB	241/-
2-LB	309/-
3-LB	452/-
4-LB	549/-
6-LB	952/-
8-LB	1,127/-

Locksmith Hammer



Size	Price
300 Gms	219/-
500 Gms	285/-



Size	Price
1-LB	90/-
1.5-LB	138/-
2-LB	172/-
3-LB	260/-
4-LB	355/-
6-LB	505/-
8-LB	679/-

Claw Hammer - Drop Forged



Size	Price
227 gms	240/-
340 gms	265/-
453 gms	330/-

Copper Hammer



Size	Price
25 mm	1,820/-
32 mm	2,700/-
38 mm	3,730/-
44 mm	4,750/-
50 mm	6,162/-
70 mm	18,650/-

Ball Pein Hammer - Drop Forged



Size	Price
200 gms	198/-
300 gms	228/-
500 gms	292/-
600 gms	350/-
800 gms	460/-

Aluminium Hammer



Size	Price
30 mm	495/-
40 mm	575/-
50 mm	850/-

Non Rebound Hammer



Size	Price
40 mm	425/-
50 mm	485/-

Nylon Hammer- Cellulose Acetate



Size	Price
20 mm	141/-
25 mm	181/-
30 mm	227/-
40 mm	368/-
50 mm	531/-

Rubber Hammer



Dia	Size	Price
35 mm	60 gms	122/-
50 mm	140 gms	188/-
60 mm	260 gms	251/-
70 mm	400 gms	382/-
80 mm	620 gms	533/-

Wooden Mallet



Dia	Length	Weight	Price
35 mm	-	-	189/-
40 mm	250 mm	100 gm	231/-
50 mm	295 mm	200 gm	273/-
62 mm	330 mm	400 gm	315/-
72 mm	430 mm	575 gm	357/-

Hammer Handle - Nylon Hammer



For Size	Price
30 mm Ø	92/-
40 mm Ø	118/-
50 mm Ø	118/-

Ash Wood

Hammer Handle - Sledge Hammer



Size	Hammer Size	Price
12"	1 to 1.1/2 Lbs	48/-
14"	2 Lbs	66/-
16"	3 Lbs	74/-
18"	4 to 5 Lbs	106/-
24"	6 to 8 Lbs	185/-
30"	10 to 12 Lbs	289/-
36"	14 to 20 Lbs	402/-

Indian Hard Wood

Hammer Handle - Ball Pein Hammer



Size	Hammer Size	Price
10"	110 gms	42/-
12"	225 gms	45/-
12"	450 gms	48/-
14"	675 gms	66/-
16"	900 gms	74/-
18"	1350 gms	104/-

Indian Hard Wood

Spare Tip For Nylon Hammer



Size	Price
30 mm	57/-
40 mm	96/-
50 mm	115/-

Cold Chisel - Octagonal



Size	Price
9 mm x 125 mm	82/-
16 mm x 150 mm	102/-
22 mm x 200 mm	122/-

Cold Chisel - Flat



Size	Price
20 mm x 150 mm	120/-
25 mm x 200 mm	154/-

Cold Chisel - Hexagonal



Size	Price
9 mm x 125 mm	82/-
16 mm x 150 mm	102/-
22 mm x 200 mm	122/-
25 mm x 250 mm	202/-

File Handle - Wood



Size	Price
3"	12/-
4"	14/-
5"	17/-
6"	19/-

File Handle - Plastic



Size	File Size	Price
3"	6" and 4"	9/-
4"	10" and 8"	15/-
5"	14" and 12"	23/-

Chisel Handle



Model	Price
Wooden	31/-

Caulking Gun



Size	Model	Price
9"	YFD01	300/-



Size	Model	Price
9"	YFD09	662/-

Caulking Gun-Cordless Electric



Size	Model	Price
15"	YFJ02	12,250/-

Torque Wrench - Digital



Sq.Dr	Nm	Price
1/4"	1.5 to 30	14,200/-
1/2"	6.8 to 135	15,280/-
1/2"	10 to 200	16,360/-
1/2"	17 to 340	17,436/-
1/4"	0.6 to 12	18,670/-
1/4"	0.3 to 6	18,500/-

Torque Wrench - Micro Adjustable With Ratchet



Sq.Dr	Nm	Price
1/4"	2 to 10	7000/-
3/8"	4 to 20	7,320/-
3/8"	20 to 100	9,090/-
1/2"	40 to 200	9,046/-
1/2"	60 to 340	9,504/-
3/4"	100 to 600	31,518/-
1"	200 to 1000	41,721/-

Torque Wrench Britool Type



Sq.Dr	Nm	Price
3/8"	5 to 33	8,050/-
3/8"	12 to 68	8,500/-
1/2"	50 to 225	9,650/-
1/2"	70 to 330	10,600/-

Tool Organiser



Size	Price
9" x 8", Canvas Material.	357/-



Tool Kit



Size	Price
85 Pcs with 5 Compartment Metal Box	9,750/-

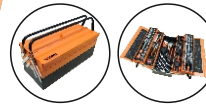

Tool Box



Size	Compartment	Price
17*9*6.5"	3	966/-
21*9*6.5"	3	1155/-
17*9*9"	5	1,365/-
21*9*9"	5	1,575/-

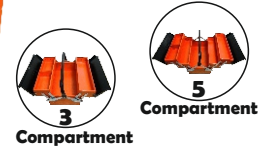

Utility Knife



Size	Price
XD 917	546/-



Size	Price
XD 886	220/-



Size	Price
XD 885	116/-



Size	Price
XD 8000	216/-



Size	Price
XD 828	326/-

Utility Knife Spare Blade



Size	Price
18mmx100x0.5	70/-
9mmx80x0.4	50/-

Tyre Lever - Hexagonal



Length	Hex	Price
12"	22 mm	365/-
16"	22 mm	487/-
18"	22 mm	548/-
24"	22 mm	731/-

Tyre Remove Flat Forged



Length	Width	Price
12"	1"	139/-
16"	1"	185/-
18"	1"	208/-
20"	1"	231/-
24"	1"	277/-

Tyre Lever - Flat Forged Heavy Duty



Length	Width	Price
12"	1 1/2"	208/-
18"	1 1/2"	311/-
24"	1 1/2"	416/-

Halfmoon Spanners Crv

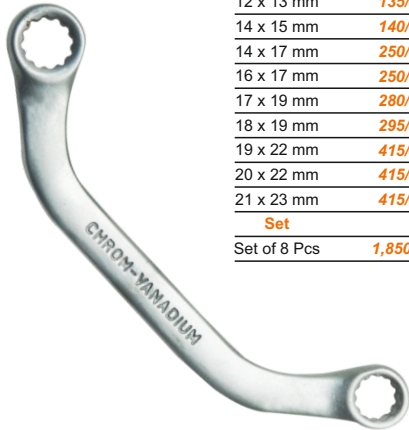

Size	Price
8 x 10 mm	125/-
10 x 11 mm	125/-
11 x 13 mm	135/-
12 x 13 mm	135/-
14 x 15 mm	140/-
14 x 17 mm	250/-
16 x 17 mm	250/-
17 x 19 mm	280/-
18 x 19 mm	295/-
19 x 22 mm	415/-
20 x 22 mm	415/-
21 x 23 mm	415/-
Set	
Set of 8 Pcs	1,850/-

Slogging Spanner - Open End



Size	Price
27 mm	866/-
30 mm	579/-
32 mm	622/-
36 mm	1,340/-
41 mm	1,046/-
46 mm	1,416/-
50 mm	1,985/-
55 mm	2,453/-
60 mm	2,880/-
65 mm	4,701/-
70 mm	4,892/-
75 mm	5,623/-
80 mm	6,258/-

Wheel Spanner

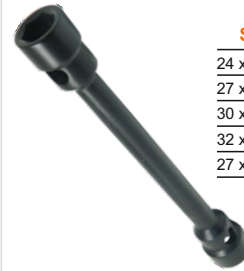

Size	Length	Price
24 x 27 mm	16"	483/-
27 x 33 mm	16"	483/-
30 x 32 mm	16"	483/-
32 x 33 mm	16"	483/-
27 x 33 mm	16"	483/-

Flare Nut Spanner



Size	Price
8 x 10 mm	72/-
10 x 11 mm	78/-
10 x 12 mm	90/-
11 x 13 mm	105/-
12 x 14 mm	130/-
14 x 17 mm	175/-
17 x 19 mm	205/-
19 x 22 mm	295/-
20 x 22 mm	300/-
24 x 27 mm	430/-
25 x 32 mm	490/-
30 x 32 mm	500/-
Set	
5 Pcs	690/-
5 pcs in Pouch	740/-

Ring Spanner (CrV)



Size	Price
32 x 36 mm	797/-
34 x 36 mm	850/-
34 x 38 mm	850/-
36 x 41 mm	995/-
41 x 46 mm	2,620/-
46 x 50 mm	3,119/-
55 x 60 mm	4,750/-
65 x 70 mm	11,500/-
Set	
6 to 22 mm - 8 Pcs	650/-
6 to 32 mm - 12 Pcs	1,530/-

Single Ended Open Jaw Spanner



Size	Price
6 mm	25/-
7 mm	27/-
8 mm	27/-
9 mm	30/-
10 mm	30/-
11 mm	32/-
12 mm	45/-
13 mm	46/-
14 mm	50/-
15 mm	52/-
16 mm	52/-
17 mm	58/-
18 mm	60/-
19 mm	62/-
21 mm	66/-
22 mm	78/-
24 mm	91/-
27 mm	120/-
30 mm	145/-
32 mm	170/-
34 mm	230/-
36 mm	255/-
38 mm	290/-
40 mm	410/-
41 mm	380/-
42 mm	440/-
46 mm	455/-
50 mm	635/-
52 mm	700/-
55 mm	950/-
60 mm	1,350/-
63 mm	1,750/-
65 mm	1,700/-
70 mm	2,800/-
75 mm	3,600/-
77 mm	3,700/-
80 mm	4,500/-
85 mm	5,700/-
88 mm	8,400/-
90 mm	8,000/-
95 mm	9,200/-
100 mm	10,450/-
105 mm	13,300/-
110 mm	17,500/-
115 mm	19,000/-
120 mm	21,000/-
125 mm	24,700/-
130 mm	26,600/-

T - Spanner



Size	Price
6 mm	130/-
7 mm	130/-
8 mm	130/-
9 mm	130/-
10 mm	130/-
11 mm	130/-
12 mm	130/-
13 mm	130/-
14 mm	130/-
15 mm	144/-
16 mm	144/-
17 mm	144/-

Adjustable Spanner



Length	Opening	Price
4"	13 mm	145/-
6"	19 mm	180/-
8"	26 mm	205/-
10"	30 mm	260/-
12"	35 mm	370/-
15"	43 mm	965/-
18"	55 mm	1,840/-

Slogging Spanner - Ring End



Size	Price
24 mm	558/-
27 mm	650/-
30 mm	684/-
32 mm	690/-
34 mm	684/-
36 mm	809/-
38 mm	837/-
41 mm	1,079/-
46 mm	1,275/-
50 mm	1,970/-
55 mm	2,162/-
60 mm	2,252/-
65 mm	2,789/-
70 mm	4,768/-
75 mm	5,313/-

Tubular Spanner



Size	Price
6 x 7 mm	27/-
8 x 9 mm	29/-
10 x 11 mm	36/-
12 x 13 mm	40/-
14 x 15 mm	59/-
16 x 17 mm	53/-
18 x 19 mm	59/-
20 x 22 mm	71/-
21 x 23 mm	82/-
24 x 26 mm	118/-
25 x 28 mm	126/-
30 x 32 mm	160/-
Set	
6 to 22 mm - 8 Pcs	359/-
6 to 32 mm - 12 Pcs	844/-

T-Allen Key



Size	Length	Price
1.5 mm	120 mm	81/-
2.0 mm	120 mm	81/-
2.5 mm	120 mm	81/-
3.0 mm	120 mm	83/-
4.0 mm	130 mm	95/-
5.0 mm	130 mm	112/-
6.0 mm	150 mm	134/-

T-Allen Key Supported - Standard

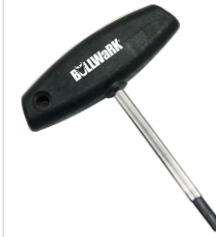

Size	Length	Price
1.5 mm	100 mm	66/-
2.0 mm	100 mm	69/-
2.5 mm	100 mm	81/-
3.0 mm	100 mm	84/-
4.0 mm	150 mm	126/-
5.0 mm	150 mm	137/-
6.0 mm	200 mm	157/-
8.0 mm	200 mm	251/-
10.0 mm	200 mm	365/-

T-Allen Key Supported - 600mm Long



Size	Length	Price
3.0 mm	600 mm	356/-
4.0 mm	600 mm	373/-
5.0 mm	600 mm	506/-
6.0 mm	600 mm	512/-
8.0 mm	600 mm	1,144/-
10.0 mm	600 mm	1,164/-

T-Allen Key Supported - 350mm Long



Size	Length	Price
2.5 mm	350 mm	94/-
3.0 mm	350 mm	138/-
4.0 mm	350 mm	193/-
5.0 mm	350 mm	255/-
6.0 mm	350 mm	260/-
8.0 mm	350 mm	343/-
10.0 mm	350 mm	535/-

Allen Key - T Ergo Model



Size	Price
2.5 mm	63/-
3.0 mm	84/-
4.0 mm	105/-
5.0 mm	126/-
6.0 mm	147/-
8.0 mm	168/-

Paint Scraper (W\$W1-120)



Length	Price
12"	130/-

Paint Scraper (W\$S1-F)



Width	Price
1"	80/-
1.5"	85/-
2"	90/-
3"	100/-
4"	120/-
5"	130/-
6"	140/-

Paint Scraper (W\$S2-R)



Width	Price
1"	112/-
1.5"	116/-
2"	120/-
3"	130/-

Paint Scraper - Multi Functional



Size	Price
3"	100/-

Center Punch - Automatic



Size	Price
5" Length	410/-
6" Length	599/-



Replaceable Tip

Center Punch



Size	Price
1/8"	34/-
5/32"	40/-
3/16"	45/-

Starting Punch



Size	Price
1/8"	57/-
5/32"	59/-
3/16"	72/-
1/4"	75/-
5/16"	88/-

Nail Punch Square Head



Size	Price
1/8"	55/-
5/32"	61/-
3/16"	67/-

Pin Punch 6"



Size	Price
1/6"	44/-
3/32"	44/-
1/8"	44/-
5/32"	44/-
3/16"	50/-
7/32"	50/-
1/4"	62/-
5/16"	78/-

Pin Punch 8"



Size	Price
1/6"	80/-
3/32"	80/-
1/8"	84/-
5/32"	88/-
3/16"	124/-
7/32"	126/-
1/4"	141/-
5/16"	151/-

Leather Punch



Size	Price
3 mm	17/-
4 mm	18/-
5 mm	18/-
6 mm	20/-
8 mm	22/-
10 mm	27/-
12 mm	47/-
14 mm	67/-
18 mm	88/-
20 mm	103/-
22 mm	158/-
25 mm	200/-
Set	
10 Pcs	533/-
12 Pcs	932/-

Junior Saw Frame



Model	Price
ABS Pistol Grip Handle	132/-



Model	Price
Wooden Handle	125/-

Hack Saw Frame



Model	Price
HS 02	280/-



Model	Price
HS 06	265/-



Model	Price
HS 04	552/-



Model	Price
HS 03	380/-

Fret Saw Frame



Size	Price
11.5" (290 mm) Depth	250/-
11.5" (290 mm) ET1	198/-

Burnisher Tool - Straight



Size	Price
6"	84/-

Burnisher Tool - Curved



Size	Price
6"	84/-

Magnetic Angle Finder



Size	Price
4" with Magnetic Base	189/-

Magnetic Tray



Size	Price
4" Dia	90/-

Magnetic Door Latch



Model	Price
Heavy Duty, White Colour	40/-

Magnetic Hook



Size	Price
16 mm Dia, 15 Lbs capacity	100/-

Magnetic Pick-up Tool



Size	Price
20" Length, 5Lbs capacity	230/-

Magnetic Sweeper



Size	Price
18"	2,505/-

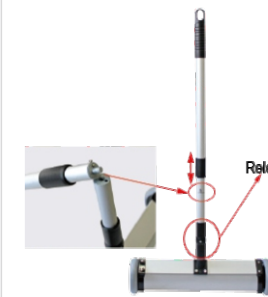

Size	Price
13"	2,360/-

Round Magnet



Size	Price
81 mm Dia, 95 Lbs	200/-

Pick-up Tool with Torch



Size	Price
750 mm	263/-

Inspection Mirror-Telescopic



Size	Price
Mirror Dia 38 mm, 215 mm Length, 680 mm Extended Length	195/-
Mirror Dia 50 mm, 19 mm Length, 350 mm Extended Length	315/-
3"	874/-

Screw Driver - Hammer Type



Size	Price
PH 2 x 150 mm	105/-
PH 2 x 200 mm	116/-
PH 2 x 250 mm	126/-
PH 2 x 300 mm	137/-
PH 3 x 150 mm	126/-
PH 3 x 200 mm	147/-
PH 3 x 250 mm	168/-
PH 3 x 300 mm	189/-

Line Tester



Model	Price
LT 100	57/-

PCB Drill

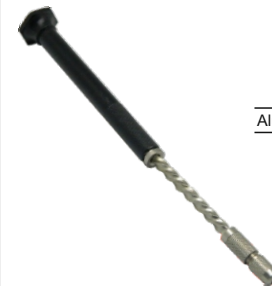

Model	Price
Aluminium Body	125/-

PVC Pipe Cutter



Model	Price
WT819A	336/-

Cable Cutter - Ratchet Type



Size	Price
32"	4,745/-
38"	9,200/-

Cable Cutter



Size	Price
18"	910/-
24"	1,060/-
32"	1,810/-

Pipe Cutter



Model	Price
WT 800	3,510/-

Steel Strap Cutter



Size	Price
18"	3,000/-

Steel Strap Cutter - With Safety Holder



Size	Price
12"	1,900/-

Wire Rope Cutter



Size	Price
8"	760/-
18"	1,700/-
24"	2,060/-
36"	3,060/-
42"	4,160/-

Tin Cutter - Jewellers



Size	Price
7"	189/-

Tin Cutter - Heavy Duty



Size	Price
10"	355/-
12"	455/-
14"	560/-

Bolt Cutter - HSS Blade (TD Model)



Size	Price
8"	360/-
12"	640/-
14"	780/-
18"	1,020/-
24"	1,380/-
36"	2,540/-

Bolt Cutter - HSS Blade (Record Type)



Size	Price
14"	617/-
18"	836/-
24"	1,208/-
30"	1,742/-
36"	3,400/-

Pipe Cutter



Model	Price
WT 808	910/-

Tube Cutter



Size	Price
3 to 32 mm	315/-

Tube Cutter - Mini



Size	Price
3 to 22 mm	200/-

T - Bar Clamp

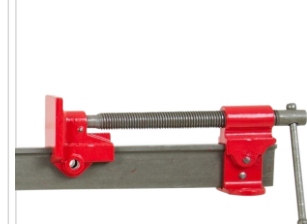

Size	Price
3 Feet	1,247/-
4 Feet	1,386/-
5 Feet	1,525/-
6 Feet	1,663/-
8 Feet	1,940/-

Vice Grip Plier



Size	Price
10"	203/-

Lead Sealing Plier



Size	Price
10 mm	275/-

Tinman's Snips - Duck Mouth



Size	Price
12"	500/-

Water Pump Plier



Size	Price
10"	200/-

Long Nose Plier



Size	Price
6"	415/-

Pro Series

Combination Plier



Size	Price
8"	547/-

Pro Series

Diagonal Cutting Plier



Size	Price
6"	445/-

Pro Series

Chain Pipe Wrench



Size	Price
3"	959/-
4"	1,301/-
6"	1,510/-
8"	1,786/-

Fly Wheel Wrench



Model	Price
YC01021	360/-

Oil Filter Wrench



Heavy Duty	
Size	Price
60-73 mm	266/-
73-85 mm	266/-
85-95 mm	277/-
95-110 mm	277/-



Model	Price
3 Jaw Two Way	386/-

Tap Wrench - Ratchet



Size	Price
2.6 mm - 5.5 mm	578/-
4.6 mm - 8 mm	788/-

Pipe Wrench - Rigid Type Heavy Duty



Size	Price
14"	790/-
18"	1,200/-
24"	1,825/-



Size	Price
12"	748/-
14"	919/-
18"	1,040/-
24"	1,502/-
36"	3,289/-
48"	5,968/-

Pipe Wrench - Rigid Type Heavy Duty Aluminium



Size	Price
24"	2,510/-
36"	5,240/-
48"	8,730/-

Cros Wheel Wrench



Size	Price
17x19x21x23mm	263/-
17x18x19x21mm	315/-

One For All Wrench (CrV)



Size	Price
8 to 22 mm	289/-

Quick Hold Wrench (CrV)



Round



Square



Hexagon



Size	Price
8 to 22 mm	740/-

Tire Wrench



Size	Price
19 mm	110/-
21 mm	117/-
Telescopic Handle with 17 mm to 21 mm Sockets	262/-

Belt Wrench



Size	Price
9"	550/-

L Wheel Wrench



Size	Price
19 mm	143/-

Pop Riveter - Heavy Duty

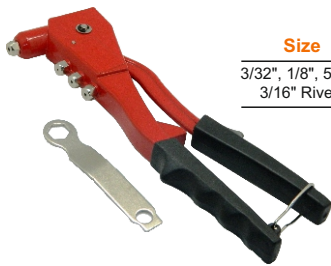

Size	Price
3/32", 1/8", 5/32", 3/16" Rivets	-/-

Pop Riveter - Professional Type



Size	Price
3/32", 1/8", 5/32", 3/16" Rivets	-/-

Pop Riveter - Free Section Type



Size	Price
3/32", 1/8", 5/32", 3/16" Rivets	-/-

Nut Riveter



Size	Price
Heavy Duty, 3/32", 1/8", 5/32", 3/16" Rivets	2,400/-

Pop Riveter



Size	Price
3/32", 1/8", 5/32" Rivets	930/-

Pop Riveter - Lazy Tone Type and Scissor Action Type

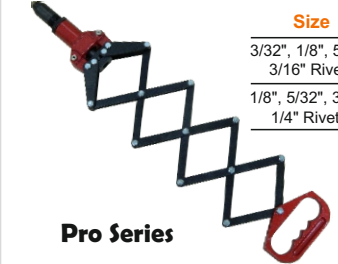

Size	Price
3/32", 1/8", 5/32", 3/16" Rivets	3,938/-
1/8", 5/32", 3/16", 1/4" Rivets	4,104/-

Pro Series

Pop Riveter - Lever Type



Size	Price
1/8", 5/32", 3/16", 1/4" Rivets	2,640/-

Pro Series

Pop Riveter - Stainless Steel Type



Size	Price
1/8", 5/32", 3/16" Rivets	896/-

Screw Driver Set



Size	Price
7 in 1	440/-



Stainless Steel Tweezer



Size	Price
2Pcs Set	84/-
4Pcs Set	158/-
6Pcs Set	284/-

Adaptors



Size	Price
1/4" (25 mm)	24/-
1/4" (65 mm)	70/-
1/2" (65 mm)	130/-

Bearing Puller - Self Centering SKF Type



Size	Price
6" x 2 Jaw	3,990/-
6" x 3 Jaw	5,250/-

Pro Series

Bearing Puller - Bar Type



Size	Price
3"	690/-
5"	760/-
6"	1,355/-
8"	1,625/-
10"	3,535/-
14"	5,190/-
21"	6,945/-

Bearing Puller - Drop Forged Steel (Heavy duty, Interchangeable Hard Tip)



Size	Price
4"	353/-
6"	657/-
8"	992/-



Size	Price
4"	377/-
6"	684/-
8"	1,067/-
10"	1,477/-

Bearing Puller - Drop Forged Steel (GT Model)



Size	Price
4"	490/-
6"	820/-
8"	1,350/-
10"	1,367/-
12"	2,800/-

Bearing Puller - Internal

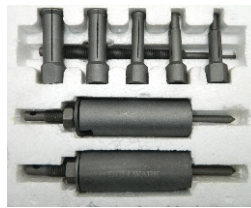

Size	Price
Set of 8 Pcs	1,260/-

Armature Bearing Puller



Size	Price
19 to 35 mm	336/-
25 to 75 mm	525/-

Tie - Rod End Puller



Model	Price
Heavy Duty	1,120/-

Steering Wheel Puller



Size	Price
Set of 13 Pcs	674/-

Ball Joint Puller



Size	Price
12 to 50 mm	1,300/-
60 to 80 mm	1,682/-

Pipe Die Set - Ratchet Type



Size	Price
WT 1035D	3,110/-



Size	Price
WT 1050	4,510/-

PPR Welding Machine



Size	Price
20 - 40 mm	5,310/-
20 - 63 mm	5,510/-
75 - 110 mm	6,380/-

Suction Lifter - Plastic



Model	Cups	Price
AS 1	1	415/-
AS 2	2	595/-
AS 3	3	835/-

Feeler Gauge Set - 26 Blades



Size	Price
100 mm	266/-
150 mm	486/-

Suction Lifter - Aluminium



Model	Cups	Price
GS 1	1	670/-
GS 17	2	895/-
GS 16	3	1,085/-

Radius Gauge



Size	Price
1 mm to 7 mm	162/-
7.5 mm to 15 mm	180/-
15.5 mm to 25 mm	180/-

Impact Driver Set

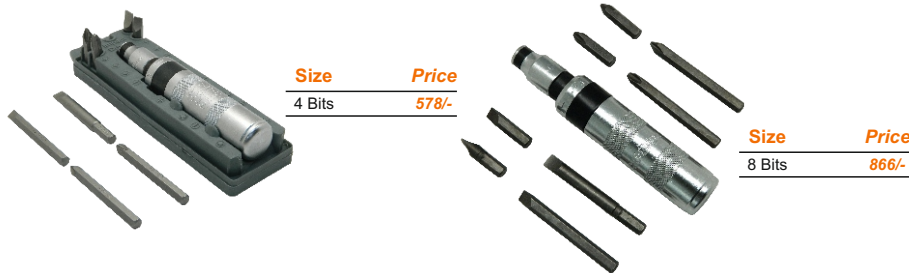

Size	Price
4 Bits	578/-

Size	Price
8 Bits	866/-

Stud Remover



Size	Price
1/4" to 1/2"	210/-
1/2" to 3/4"	420/-

Engineers Sthescope



Size	Price
12" x 1/4"	496/-

Magnetic Welding Clamp



Size	Price
Small	147/-
Big	189/-

Metal Marker-Electric

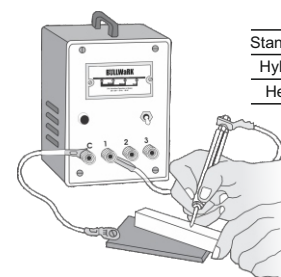

Size	Price
Standard Model	2080/-
Hybrid Model	3,500/-
Heavy Duty	4,200/-

Plumb Bob



Size	Price
37 mm Length 17 mm Width	168/-

Case Opener



Size	Price
3", CO3	44/-

Magnetic Direction Compass



Size	Price
Heavy Stainless Steel	63/-
Magnifier and Mirror	179/-

Impact Tools

Allen Socket	1/4" Drive		3/8" Drive		1/2" Drive		3/4" Drive		1" Drive	
		3 mm ₹ 203/-	4 mm ₹ 203/-	3 mm ₹ 143/-	4 mm ₹ 143/-	6 mm ₹ 209/-	8 mm ₹ 209/-	12 mm ₹ 504/-	14 mm ₹ 504/-	17 mm ₹ 1,091/-
	5 mm ₹ 203/-	6 mm ₹ 203/-	5 mm ₹ 143/-	6 mm ₹ 143/-	10 mm ₹ 221/-	12 mm ₹ 243/-	17 mm ₹ 529/-	19 mm ₹ 551/-	22 mm ₹ 1,169/-	24 mm ₹ 1,235/-
	8 mm ₹ 203/-	10 mm ₹ 216/-	8 mm ₹ 143/-	10 mm ₹ 150/-	13 mm ₹ 287/-	14 mm ₹ 304/-	20 mm ₹ 617/-	22 mm ₹ 650/-	27 mm ₹ 1,301/-	30 mm ₹ 1,345/-
					17 mm ₹ 326/-	19 mm ₹ 342/-	24 mm ₹ 662/-		32 mm ₹ 1,389/-	36 mm ₹ 1,499/-
					36 mm ₹ 1,428/-					

Extension Bar	1/4" Drive		3/8" Drive		1/2" Drive		3/4" Drive		1" Drive		1.1/4" Drive	1.1/2" Drive
		3" ₹ 176/-	4" ₹ 209/-	3" ₹ 207/-	4" ₹ 220/-	2" ₹ 99/-	3" ₹ 110/-	8" ₹ 397/-	10" ₹ 441/-	4" ₹ 1,103/-	5" ₹ 1,279/-	
	5" ₹ 232/-	6" ₹ 265/-	5" ₹ 269/-	6" ₹ 298/-	5" ₹ 143/-	10" ₹ 198/-	15" ₹ 617/-	8" ₹ 1,654/-	10" ₹ 2,051/-			
	8" ₹ 287/-	10" ₹ 309/-	8" ₹ 386/-	10" ₹ 437/-				12" ₹ 2,426/-	16" ₹ 3,087/-			
	12" ₹ 375/-							20" ₹ 5,292/-				

Extension Socket	3/8" Drive	
		5 mm ₹ 393/-
	9 mm ₹ 393/-	10 mm ₹ 393/-
	11 mm ₹ 397/-	12 mm ₹ 397/-
	13 mm ₹ 419/-	14 mm ₹ 419/-
	15 mm ₹ 441/-	16 mm ₹ 441/-
	17 mm ₹ 478/-	18 mm ₹ 478/-
	19 mm ₹ 529/-	20 mm ₹ 529/-
	21 mm ₹ 551/-	22 mm ₹ 573/-
	24 mm ₹ 617/-	

Socket Adaptor	3/8" Drive	
		3/8" F x 1/4" M ₹ 168/-
	1/2" F x 3/8" M ₹ 232/-	3/8" F x 1/2" M ₹ 209/-
	1/2" F x 1/4" M ₹ 243/-	3/4" F x 1/2" M ₹ 287/-
	3/4" F x 1/2" M ₹ 287/-	1/2" F x 3/4" M ₹ 309/-
	3/4" F x 3/8" M ₹ 419/-	3/4" F x 1" M ₹ 485/-
	1" F x 3/4" M ₹ 772/-	1" F x 1.1/2" M ₹ 1,125/-
	1.1/2" F x 1" M ₹ 2,867/-	1.1/2" F x 2.1/2" M ₹ 3,969/-

Crow Wrench	3/8" Drive		1/2" Drive	
		5 mm ₹ 408/-	6 mm ₹ 408/-	5 mm ₹ 463/-
	7 mm ₹ 408/-	8 mm ₹ 408/-	7 mm ₹ 463/-	8 mm ₹ 485/-
	9 mm ₹ 408/-	10 mm ₹ 441/-	8 mm ₹ 485/-	9 mm ₹ 485/-
	11 mm ₹ 441/-	12 mm ₹ 441/-	9 mm ₹ 485/-	10 mm ₹ 485/-
	13 mm ₹ 441/-	15 mm ₹ 518/-	11 mm ₹ 485/-	11 mm ₹ 485/-
	16 mm ₹ 518/-	17 mm ₹ 518/-	12 mm ₹ 485/-	12 mm ₹ 485/-
	18 mm ₹ 595/-	19 mm ₹ 595/-	13 mm ₹ 485/-	13 mm ₹ 485/-
	20 mm ₹ 595/-	21 mm ₹ 595/-	14 mm ₹ 551/-	14 mm ₹ 551/-
			15 mm ₹ 551/-	15 mm ₹ 551/-
			16 mm ₹ 551/-	16 mm ₹ 551/-
			17 mm ₹ 551/-	17 mm ₹ 551/-
			18 mm ₹ 628/-	18 mm ₹ 628/-
			19 mm ₹ 628/-	19 mm ₹ 628/-
			20 mm ₹ 628/-	20 mm ₹ 628/-
			21 mm ₹ 628/-	21 mm ₹ 628/-
			22 mm ₹ 706/-	22 mm ₹ 706/-
			26 mm ₹ 794/-	26 mm ₹ 794/-
			28 mm ₹ 794/-	28 mm ₹ 794/-
			30 mm ₹ 794/-	30 mm ₹ 794/-
			32 mm ₹ 904/-	32 mm ₹ 904/-
			34 mm ₹ 904/-	34 mm ₹ 904/-

Impact Tools

Hex Socket



3/8" Drive	1/2" Drive	3/4" Drive	1" Drive	1.1/2" Drive
3 mm ₹ 123/-	5 mm ₹ 176/-	14 mm ₹ 415/-	18 mm ₹ 551/-	36 mm ₹ 2,867/-
4 mm ₹ 123/-	6 mm ₹ 176/-	17 mm ₹ 415/-	19 mm ₹ 551/-	38 mm ₹ 2,977/-
5 mm ₹ 123/-	7 mm ₹ 176/-	18 mm ₹ 415/-	20 mm ₹ 551/-	46 mm ₹ 3,087/-
6 mm ₹ 123/-	8 mm ₹ 176/-	19 mm ₹ 415/-	21 mm ₹ 551/-	50 mm ₹ 3,197/-
7 mm ₹ 123/-	9 mm ₹ 176/-	20 mm ₹ 463/-	22 mm ₹ 551/-	50 mm ₹ 3,528/-
8 mm ₹ 123/-	10 mm ₹ 176/-	21 mm ₹ 463/-	23 mm ₹ 551/-	60 mm ₹ 3,859/-
9 mm ₹ 123/-	11 mm ₹ 176/-	22 mm ₹ 463/-	24 mm ₹ 551/-	65 mm ₹ 4,355/-
10 mm ₹ 123/-	12 mm ₹ 176/-	23 mm ₹ 474/-	27 mm ₹ 584/-	70 mm ₹ 5,072/-
11 mm ₹ 137/-	13 mm ₹ 187/-	24 mm ₹ 474/-	28 mm ₹ 628/-	75 mm ₹ 5,954/-
12 mm ₹ 137/-	14 mm ₹ 187/-	25 mm ₹ 485/-	29 mm ₹ 628/-	80 mm ₹ 7,056/-
13 mm ₹ 137/-	15 mm ₹ 187/-	26 mm ₹ 485/-	30 mm ₹ 628/-	85 mm ₹ 7,938/-
14 mm ₹ 150/-	16 mm ₹ 198/-	27 mm ₹ 485/-	31 mm ₹ 684/-	90 mm ₹ 9,261/-
15 mm ₹ 165/-	17 mm ₹ 198/-	28 mm ₹ 507/-	32 mm ₹ 684/-	95 mm ₹ 11,246/-
16 mm ₹ 165/-	18 mm ₹ 198/-	29 mm ₹ 507/-	33 mm ₹ 772/-	100 mm ₹ 12,348/-
17 mm ₹ 176/-	19 mm ₹ 209/-	30 mm ₹ 529/-	34 mm ₹ 772/-	105 mm ₹ 14,112/-
18 mm ₹ 176/-	20 mm ₹ 221/-	31 mm ₹ 540/-	36 mm ₹ 838/-	110 mm ₹ 16,099/-
19 mm ₹ 207/-	21 mm ₹ 254/-	32 mm ₹ 573/-	41 mm ₹ 959/-	115 mm ₹ 16,099/-
20 mm ₹ 207/-	22 mm ₹ 254/-	33 mm ₹ 562/-	42 mm ₹ 1,014/-	120 mm ₹ 18,743/-
21 mm ₹ 216/-	23 mm ₹ 265/-	34 mm ₹ 606/-	46 mm ₹ 1,147/-	
22 mm ₹ 216/-	24 mm ₹ 298/-	36 mm ₹ 628/-	48 mm ₹ 1,257/-	
	25 mm ₹ 298/-	38 mm ₹ 761/-	50 mm ₹ 1,444/-	
	26 mm ₹ 320/-	41 mm ₹ 849/-	55 mm ₹ 1,577/-	
	27 mm ₹ 320/-	46 mm ₹ 926/-	60 mm ₹ 1,786/-	
	28 mm ₹ 342/-	50 mm ₹ 1,191/-	65 mm ₹ 2,183/-	
	29 mm ₹ 408/-	55 mm ₹ 1,441/-	70 mm ₹ 2,867/-	
	30 mm ₹ 408/-	60 mm ₹ 1,610/-	75 mm ₹ 3,528/-	
	31 mm ₹ 419/-	65 mm ₹ 1,808/-	80 mm ₹ 4,101/-	
	32 mm ₹ 419/-	70 mm ₹ 2,756/-	85 mm ₹ 5,072/-	
	34 mm ₹ 474/-		90 mm ₹ 5,557/-	
			95 mm ₹ 7,056/-	

Deep Socket



3/8" Drive	1/2" Drive	3/4" Drive	1" Drive
4 mm ₹ 172/-	5 mm ₹ 247/-	14 mm ₹ 540/-	19 mm ₹ 840/-
5 mm ₹ 172/-	6 mm ₹ 247/-	17 mm ₹ 540/-	22 mm ₹ 840/-
6 mm ₹ 172/-	7 mm ₹ 247/-	18 mm ₹ 540/-	24 mm ₹ 840/-
7 mm ₹ 172/-	8 mm ₹ 247/-	19 mm ₹ 573/-	26 mm ₹ 904/-
8 mm ₹ 172/-	9 mm ₹ 247/-	20 mm ₹ 573/-	27 mm ₹ 970/-
9 mm ₹ 172/-	10 mm ₹ 247/-	22 mm ₹ 573/-	30 mm ₹ 970/-
10 mm ₹ 172/-	11 mm ₹ 247/-	23 mm ₹ 595/-	32 mm ₹ 992/-
11 mm ₹ 176/-	12 mm ₹ 247/-	24 mm ₹ 595/-	33 mm ₹ 1,008/-
12 mm ₹ 176/-	13 mm ₹ 260/-	25 mm ₹ 617/-	36 mm ₹ 1,169/-
13 mm ₹ 198/-	14 mm ₹ 260/-	26 mm ₹ 617/-	38 mm ₹ 1,279/-
15 mm ₹ 209/-	15 mm ₹ 265/-	28 mm ₹ 662/-	41 mm ₹ 1,323/-
16 mm ₹ 209/-	16 mm ₹ 280/-	29 mm ₹ 662/-	44 mm ₹ 1,510/-
17 mm ₹ 243/-	17 mm ₹ 280/-	30 mm ₹ 739/-	46 mm ₹ 1,510/-
18 mm ₹ 243/-	18 mm ₹ 304/-	32 mm ₹ 816/-	50 mm ₹ 1,753/-
19 mm ₹ 276/-	19 mm ₹ 309/-	34 mm ₹ 838/-	55 mm ₹ 2,249/-
20 mm ₹ 276/-	20 mm ₹ 309/-	36 mm ₹ 849/-	60 mm ₹ 2,833/-
21 mm ₹ 287/-	21 mm ₹ 320/-	38 mm ₹ 1,014/-	65 mm ₹ 3,285/-
22 mm ₹ 287/-	22 mm ₹ 353/-	41 mm ₹ 1,147/-	70 mm ₹ 3,947/-
	23 mm ₹ 353/-	45 mm ₹ 1,400/-	75 mm ₹ 4,212/-
	24 mm ₹ 353/-	46 mm ₹ 1,400/-	80 mm ₹ 5,094/-
	25 mm ₹ 441/-	50 mm ₹ 1,654/-	85 mm ₹ 5,535/-
	26 mm ₹ 441/-	55 mm ₹ 2,271/-	90 mm ₹ 6,196/-
	27 mm ₹ 474/-	60 mm ₹ 2,481/-	
	28 mm ₹ 529/-	65 mm ₹ 2,690/-	
	29 mm ₹ 529/-		
	30 mm ₹ 573/-		
	32 mm ₹ 595/-		
	34 mm ₹ 628/-		
	36 mm ₹ 662/-		
	38 mm ₹ 750/-		

Impact Tools

Stud Tightener

3/8" Drive		1/2" Drive		3/4" Drive	
M6 x 1	₹ 309/-	M8 x 1	₹ 309/-	M14 x 2	₹ 706/-
M7 x 1	₹ 309/-	M10 x 1.5	₹ 309/-	M16 x 2	₹ 706/-
M8 x 1	₹ 309/-	M8 x 1.25	₹ 353/-	M18 x 1.5	₹ 783/-
M10 x 1.5	₹ 342/-	M12 x 1.75	₹ 375/-	M20 x 2.5	₹ 783/-
M12 x 1.25	₹ 375/-	M12 x 1.25	₹ 518/-	M22 x 3	₹ 860/-
M12 x 1.75	₹ 375/-	M14 x 2	₹ 540/-		
		M16 x 2	₹ 573/-		
		M18 x 1.5	₹ 639/-		
		BSF;UNF;UNC			
		5/16"	₹ 364/-		
		3/8"	₹ 386/-		
		1/2"	₹ 518/-		
		7/16"	₹ 518/-		
		9/16"	₹ 540/-		
		5/8"	₹ 573/-		
		3/4"	₹ 684/-		
				BSF;UNF;UNC	
				5/8"	₹ 639/-
				9/16"	₹ 772/-
				3/4"	₹ 750/-
				7/8"	₹ 772/-
				1"	₹ 882/-
				1-1/4"	₹ 1,014/-
				1-1/2"	₹ 1,080/-

L - Handle

Sq.Dr	Size	Price
1/2"	56 mm x 190 mm	₹ 176/-
1/2"	75 mm x 250 mm	₹ 216/-
1/2"	75 mm x 300 mm	₹ 238/-
3/4"	18" Heavy Duty	₹ 441/-

T - Handle

Sq.Dr	Size	Price
1/2"	10"	₹ 184/-
3/8"	-	₹ 221/-
1/2"	12"	₹ 220/-
3/4"	20"	₹ 606/-
1"	-	₹ 2,161/-

Universal Joint

3/8" Sq	₹ 507/-
1/2" Sq	₹ 595/-
3/4" Sq	₹ 1,191/-
1"	₹ 2,646/-

Nozzle Socket

Sq.Dr	Size	Price
1/2"	30 mm	₹ 273/-
1/2"	32 mm	₹ 273/-

Nut Runner

Size	Price	Size	Price	Size	Price	Size	Price
4 x 75	187/-	13 x 75	221/-	4 x 100	232/-	13 x 100	254/-
5 x 75	187/-	14 x 75	232/-	5 x 100	232/-	14 x 100	265/-
5.5 x 75	187/-	15 x 75	232/-	5.5 x 100	232/-	15 x 100	265/-
6 x 75	187/-	16 x 75	243/-	6 x 100	232/-	16 x 100	287/-
7 x 75	187/-	17 x 75	254/-	7 x 100	232/-	17 x 100	309/-
8 x 75	187/-	18 x 75	276/-	8 x 100	232/-	18 x 100	342/-
9 x 75	209/-	19 x 75	276/-	9 x 100	232/-	19 x 100	342/-
10 x 75	209/-	20 x 75	298/-	10 x 100	243/-	20 x 100	364/-
11 x 75	209/-			11 x 100	243/-	13 x 150	408/-
12 x 75	221/-			12 x 100	254/-		

First Aid Box



Size	Price
210 x 170 x 150 mm	499/-
330 x 170 x 200 mm	700/-

Leather Gloves



Size	Price
14"	
Natural Color	252/-
14"	
Orange Color	252/-
18"	
Maroon Color	315/-

Air Blow Gun (DG-10)



Size	Price
with 4" Long Nozzle	179/-

Grease Gun



Size	Price
200 CC	252/-
300 CC	305/-
500 CC	420/-

Swedge Block

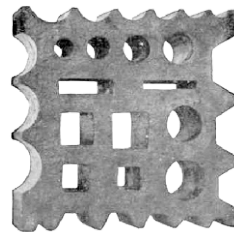

Size	Price
50 Kg	6,825/-

Mini Hand Drilling Machine



Size	Price
3 mm, Pin Chuck, Plastic Body	252/-

Diamond Needle File

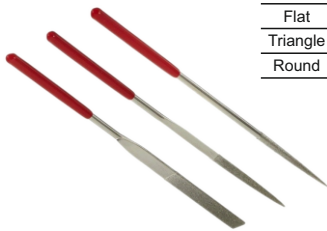

Size	Price
Flat	58/-
Triangle	58/-
Round	58/-

Diamond Needle File - Set



Size	Price
6" x 4 mm Handle Dia	225/-

Hook and Pick Set

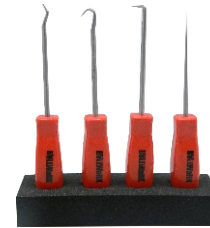

Size	Price
4 Pcs	200/-
10 Pcs	386/-

Oil Can



Size	Price
1/4 Pint	71/-
1/2 Pint	90/-

Impact Bit - Short



Size	Price
Ph2 - 2 Nos	
Ph3 - 2 Nos	101/-
Ph2 - 4 Nos	101/-
Ph3 - 4 Nos	101/-
Ph2 - 1 No	
Ph3 - 1 No	
8 mm Flat - 1 No	
10 mm Flat - 1 No	101/-

Impact Bit - Long



Size	Price
Ph2 - 2 Nos	
Ph3 - 2 Nos	195/-
Ph2 - 4 Nos	195/-
Ph3 - 4 Nos	195/-
Ph2 - 1 No	
Ph3 - 1 No	
8 mm Flat - 1 No	
10 mm Flat - 1 No	195/-

Grease Gun Extension - Hose



Size	Price
12"	69/-
18"	101/-

Grease Nipple



Size	Price
Male Ended	12/-
Female Ended	12/-
Bent Type	13/-
Straight Type	13/-



Size	Price
Male Ended	9/-
Female Ended	9/-
15 mm (Hex Collar)	29/-
17 mm (Hex Collar)	48/-
19 mm (Hex Collar)	55/-

